

Composite Fences installation guide 2021

Composite fences by SAiGE are easy to install whilst offering a long-lasting and stylish solution.

Please ensure Installation is followed as per the Installation Guides for SAiGE's warranty to apply. For any clarification or information please contact a member of the SAiGE Team on 01789 721 576 or email info@saigedecking.com

HIGH STRENGTH

HIGH SPECIFICATION

BRITISH DESIGN

AWARD WINNING

QUALITY AND TEST CERTIFICATION









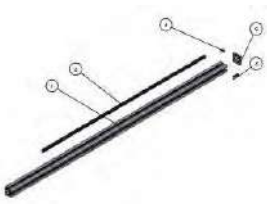

100% QUALITY INSPECTION

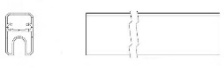
Composite Fences by SAiGE

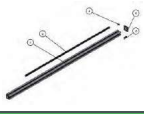
Posts into
ground

SAiGE
Composite Products

Fencing Component list

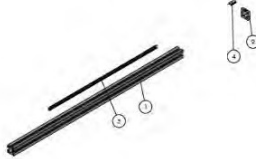
Image	Quantity per bay	Product Description	Dimensions	Weight
1.8m x 1.8m Fence (sunk in the ground)				57kg
	1	1. 2.4m post	70mm x 70mm x 2400mm	7.4kg
	1	2. Post cap		
	1	3. 1.815m Insert		
	1	4. 55mm Insert		
	1	5. 20 mm insert		
	1	Bottom Rail	1748mm x 30mm x 20mm	0.8kg
	1	Top Rail	1748mm x 30mm x 20mm	0.7kg
	1	1 Pack (4 Included with screws)	25mm x 24mm x 2mm	0.02kg
	12	FSC® 100% Composite Fence boards	145mm x 1755mm x 19.5mm	3.85kg e.a.
Additional Finishing post				
	1	Additional post kit as above to finish end of run	70mm x 70mm x 2400mm	7.4kg
4ft Fence (sunk into the ground)				39.3kg
	1	1. 1815mm post	70mm x 70mm x 1815mm	8.5kg
	1	2. Post cap		
	1	3. 20mm Insert		
	1	4. 55mm Insert		
	1	5. 1185mm Insert		
	1	Bottom Rail	1748mm x 30mm x 20mm	0.8kg
	1	Top Rail	1748mm x 30mm x 20mm	0.7kg
	1	1 Pack (4 Included & Screws)		0.02kg
	8	FSC® 100% Composite Fence boards	145mm x 1755mm x 19.5mm	3.85kg e.a.
Additional Finishing post				
		Additional post kit to finish	70mm x 70mm x 1815mm	8.5kg

1

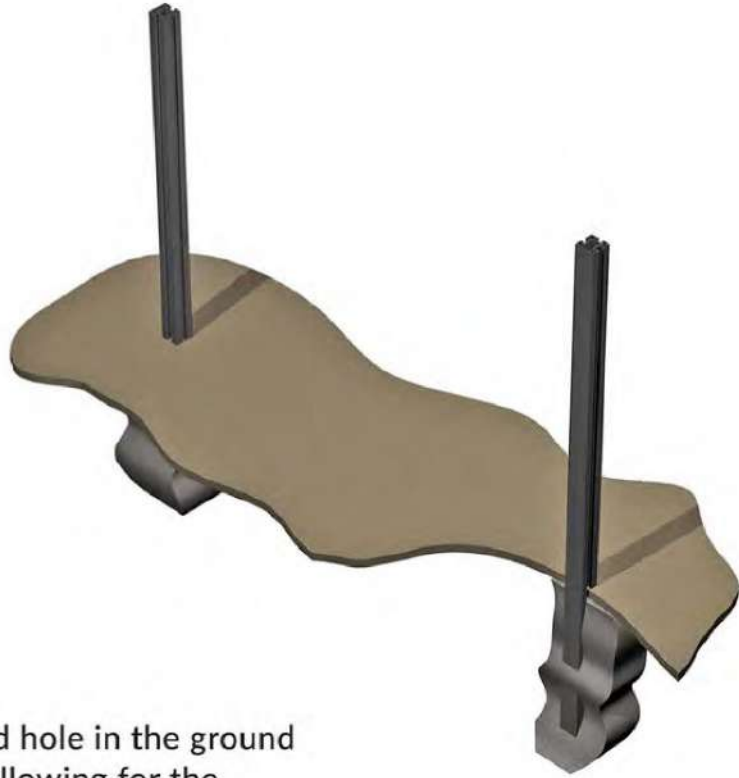

Dig a sufficient sized hole in the ground to accept the post allowing for the desired fence height.

2

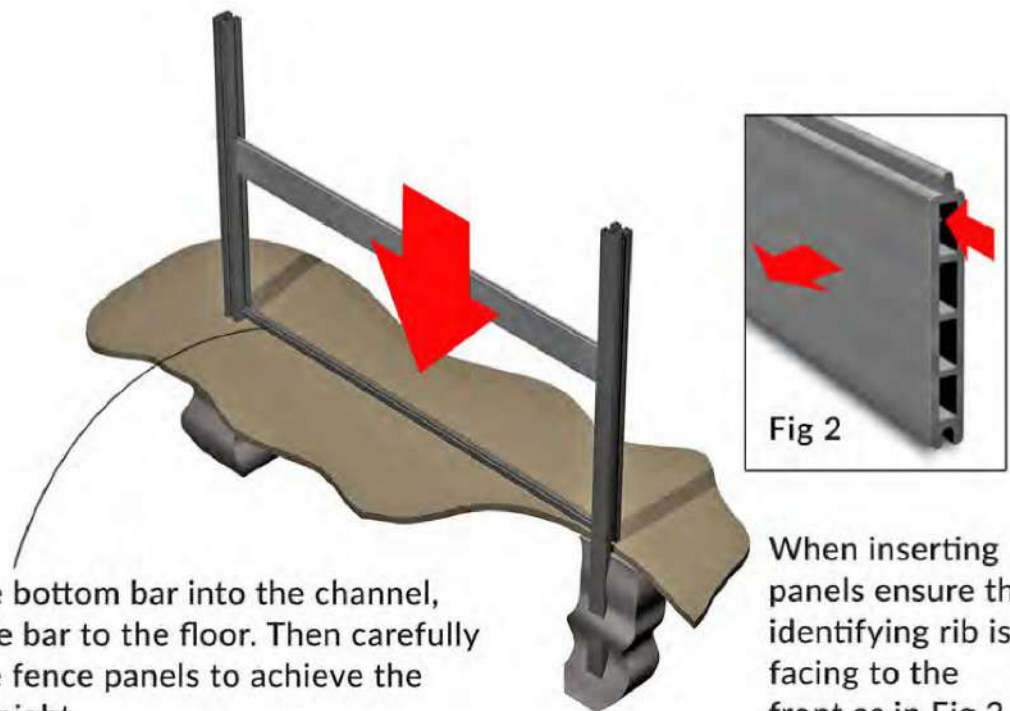

Insert the bottom bar into the channel, sliding the bar to the floor. Then carefully insert the fence panels to achieve the desired height.

When inserting panels ensure the identifying rib is facing to the front as in Fig 2.

3

Post cap
Insert

Insert top bar and small inserts into the channel of the post. Finally, add the post cap to the post.

4

Completed fence:
Using instructions 1 to 3.

Composite Fences by SAiGE

With baseplate

Fencing Component list



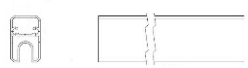
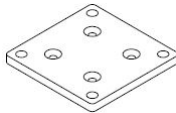

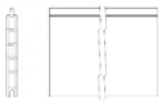

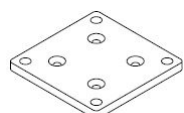

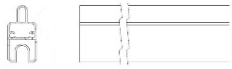
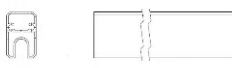
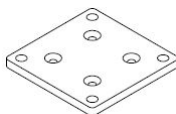

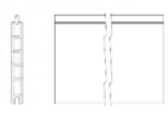

Image	Quantity per bay	Product Description	Dimensions	Weight
1.8m x 1.8m Fence (with baseplates)				
	1	1. 1815mm post	70mm x 70mm x 1815mm	8.5kg
	1	2. Post cap		
	1	3. 20mm Insert		
	1	4. 55mm Insert		
	1	5. 1185mm Insert		
	1	Bottom Rail	1748mm x 30mm x 20mm	0.8kg
	1	Top Rail	1748mm x 30mm x 20mm	0.7kg
	1	10mm baseplate	130mm x 130mm x 10mm	2.5kg
	4	Bolts to attach baseplate to post		
	4	Concrete fixing bolts		
	1	1 Pack (4 Included with screws)	25mm x 24mm x 2mm	0.02kg
	12	FSC [®] 100% Composite Fence boards	145mm x 1755mm x 19.5mm	3.85kg e.a.
Additional Finishing post and baseplate				
	1	Additional post kit to finish	70mm x 70mm x 1815mm	4.8kg
	1	Additional baseplate to finish	130mm x 130mm x 10mm	2.5kg

Image	Quantity per bay	Product Description	Dimensions	Weight
4ft Fence (with baseplates)				38.1kg
	1	1. 1.54mm post	70mm x 70mm x 1540 mm	4.8kg
	1	2. Post cap		
	1	3. 1540mm Insert		
	1	4. 55mm Insert		
	1	5. 1.54mm Post		
	1	Bottom Rail	1748mm x 30mm x 20mm	0.8kg
	1	Top Rail	1748mm x 30mm x 20mm	0.7kg
	1	Baseplate	130mm x 130mm x 10mm	2.5kg
	1	1 Pack (4 Included with screws)	25mm x 24mm x 2mm	0.02kg
	8	FSC [®] 100% Composite Fence boards	145mm x 1755mm x 19.5mm	3.85kg e.a.
Additional Finishing post and Baseplate				
	1	Additional post kit to finish	70mm x 70mm x 1540mm	4.8kg
	1	Additional baseplate to finish	130mm x 130mm x 10mm	2.5kg

1

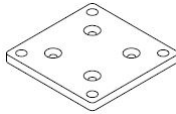
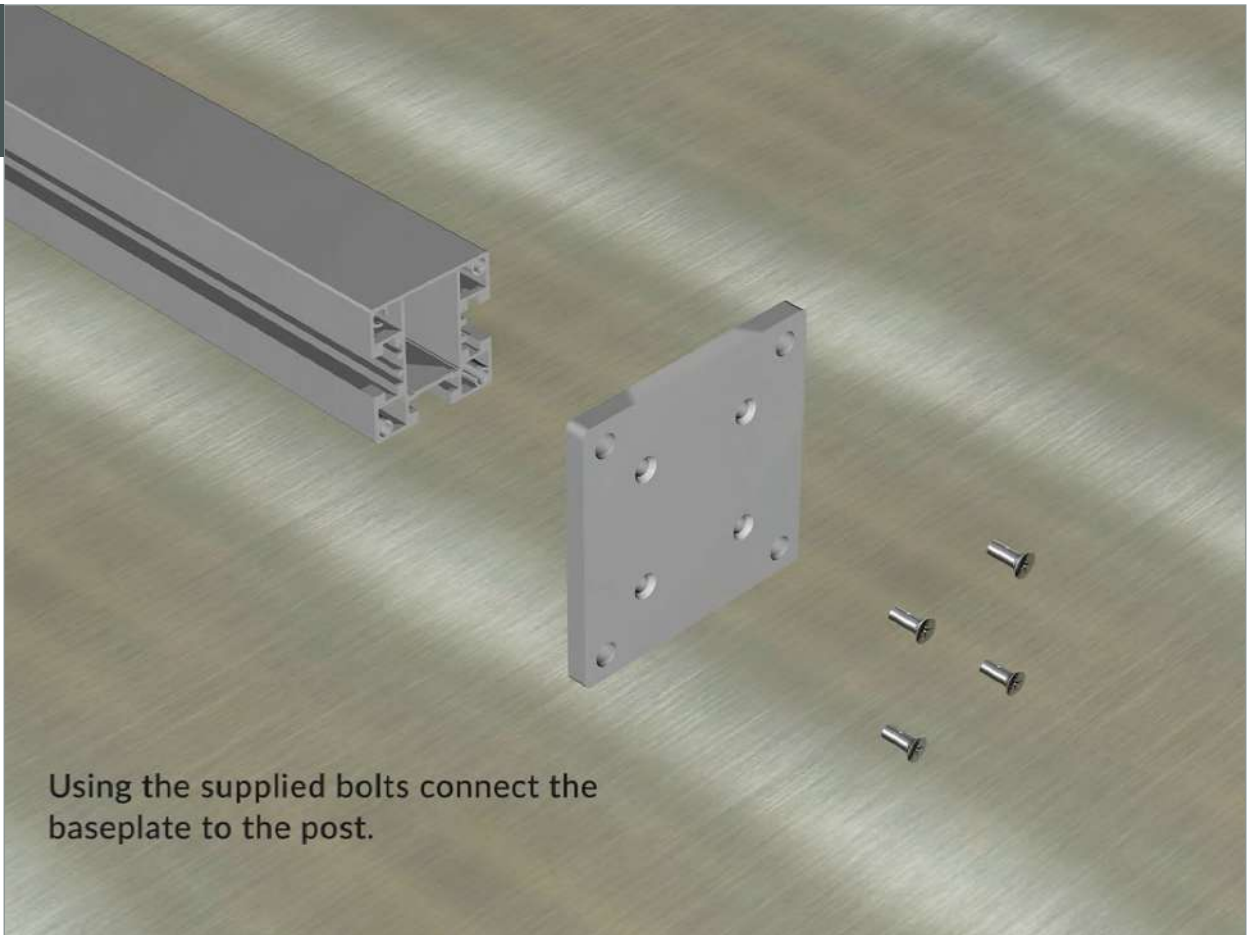

Using the supplied bolts connect the baseplate to the post.

2

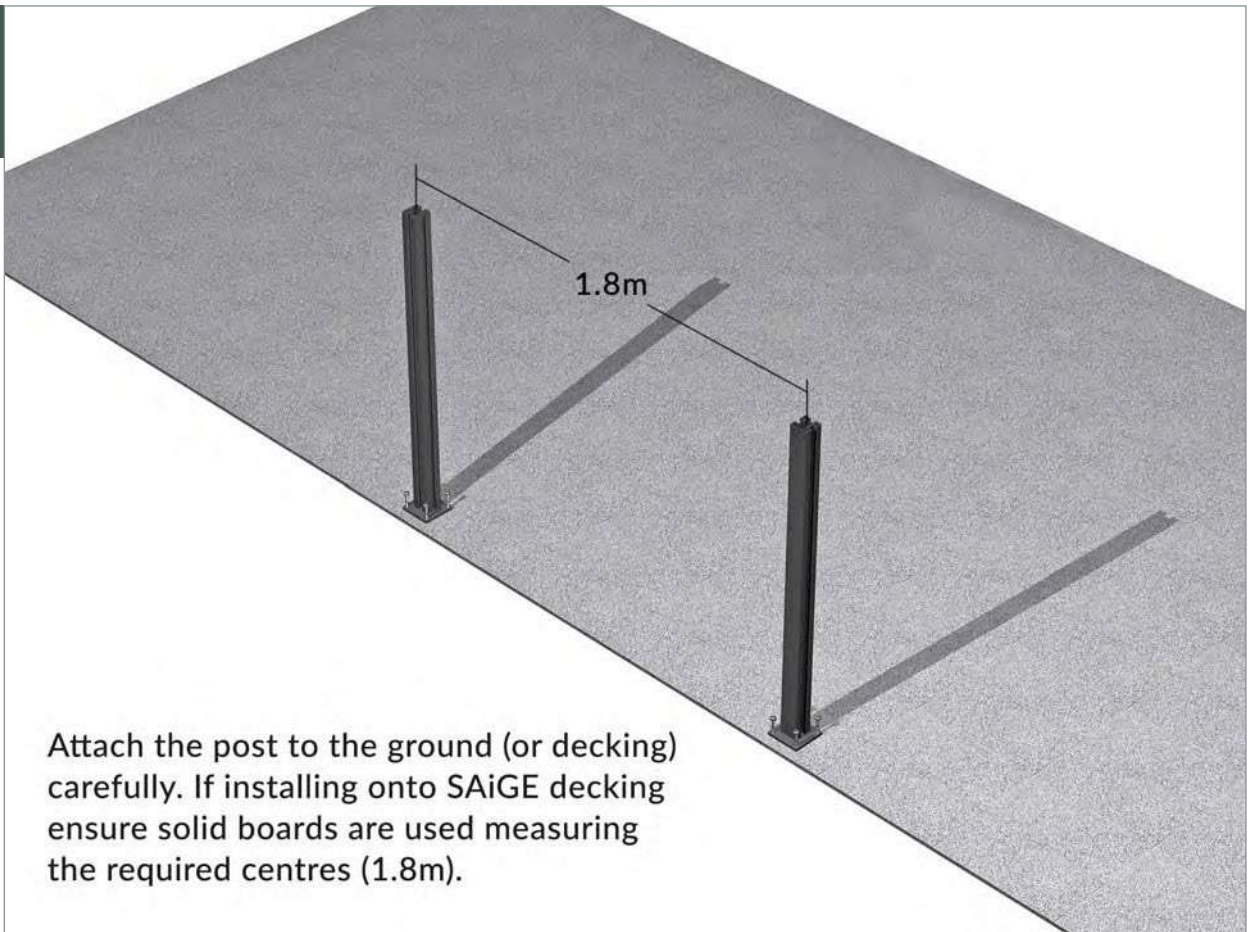

Attach the post to the ground (or decking) carefully. If installing onto SAiGE decking ensure solid boards are used measuring the required centres (1.8m).

3

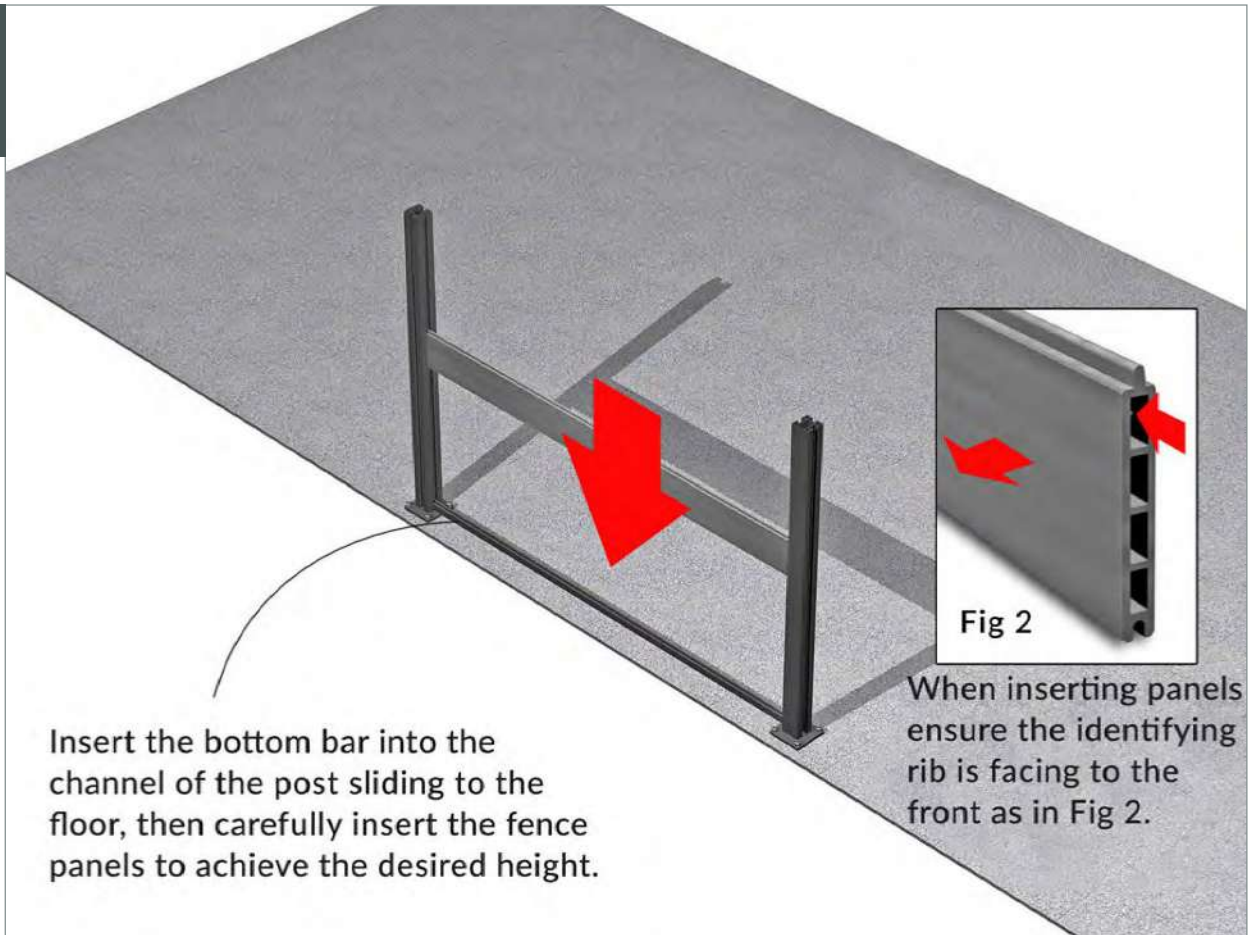

4

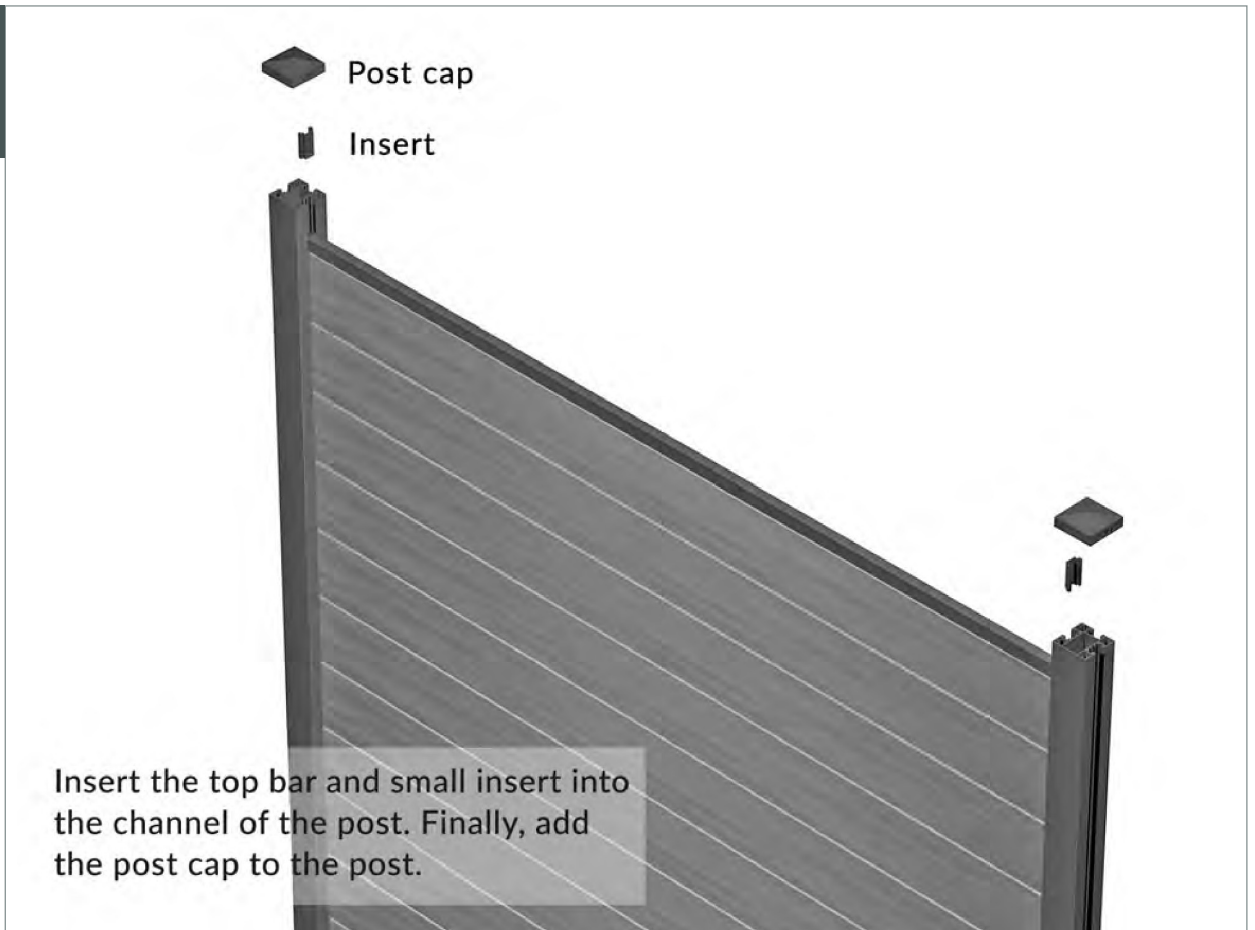

5

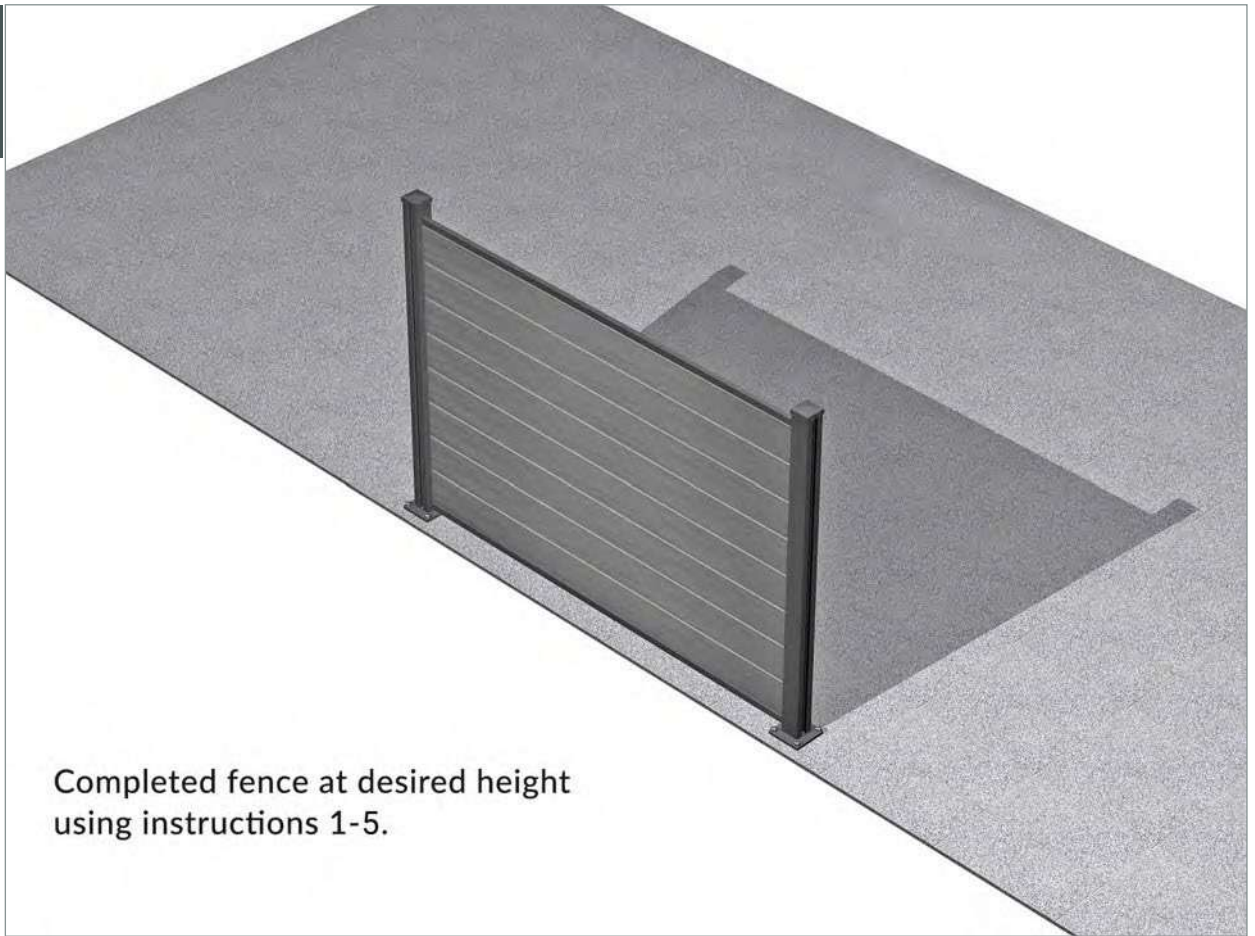







Composite Fences by SAiGE

Ranch style

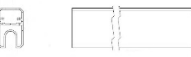
(2 and 3 board options available)

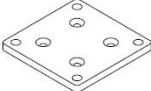
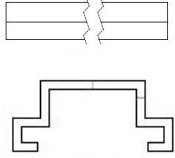
Ranch Style Fence Component list

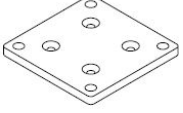
Image	Quantity per bay	Product Description	Dimensions	Weight
3 Board Ranch Fence (can be sunk in the ground or fixed using baseplates)				21.75kg
	1	1. 1.54m post	70mm x 70mm x 1540mm	4.8kg
	1	2. Post cap		
	1	3. 1540mm Insert		
	1	4. 55mm Insert		
	3	Bottom Rail	1748mm x 30mm x 20mm	0.8kg e.a.
	3	Top Rail	1748mm x 30mm x 20mm	0.7kg e.a.
	3	1 Pack (4 Included & Screws)	25mm x 24mm x 2mm	0.02kg
	3	FSC [®] 100% Composite Fence boards	145mm x 1755mm x 19.5mm	3.85kg e.a.
	1	Baseplate if sinking into the ground	130mm x 130mm x 10mm	2.5kg
	1	1155mm Insert	1155mm	0.4kg
Additional Finishing post and baseplate				
	1	Additional post kit to finish	70mm x 70mm x 1540mm	4.8kg
	1	Additional baseplate to finish	130mm x 130mm x 10mm	2.5kg

1

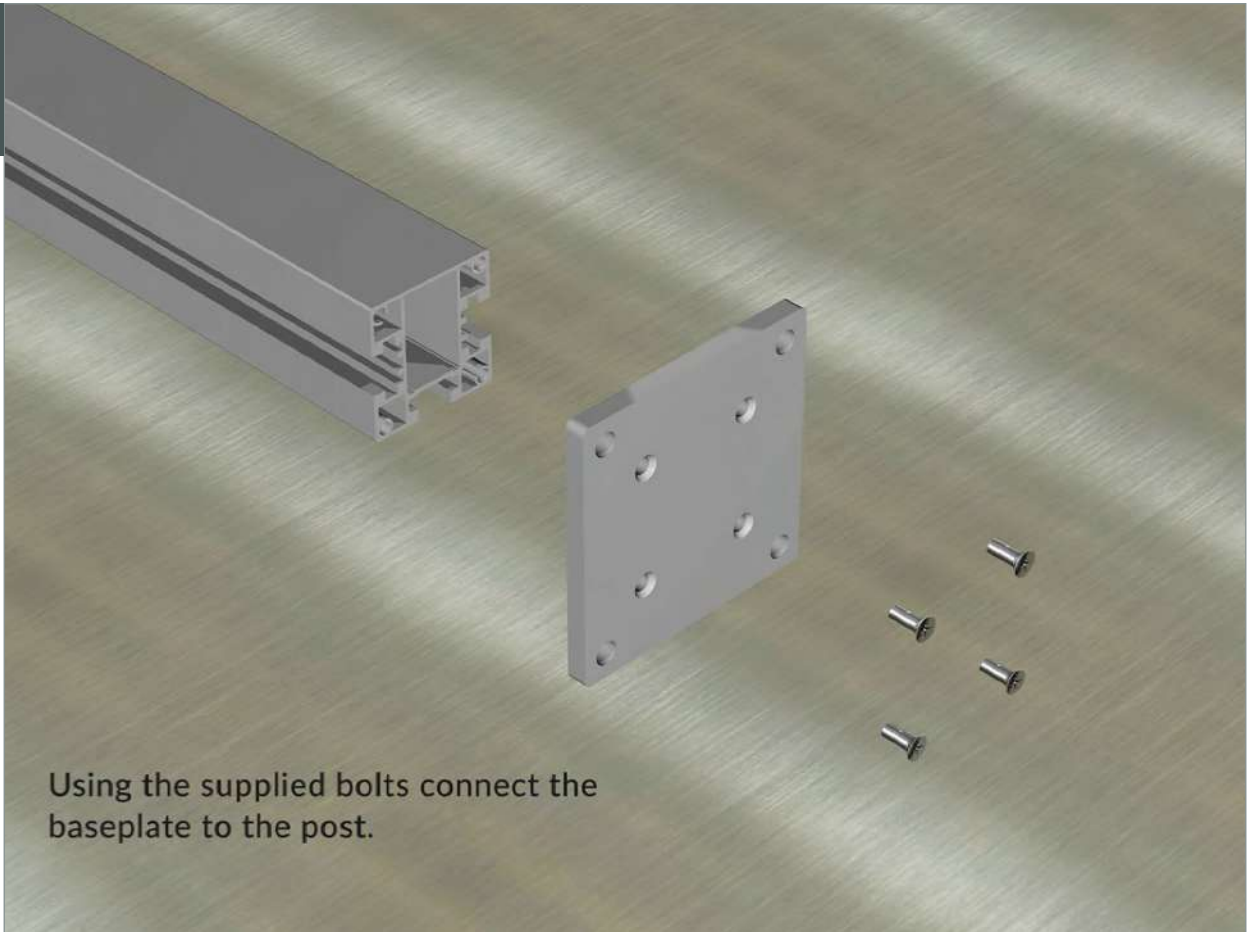

Using the supplied bolts connect the baseplate to the post.

2

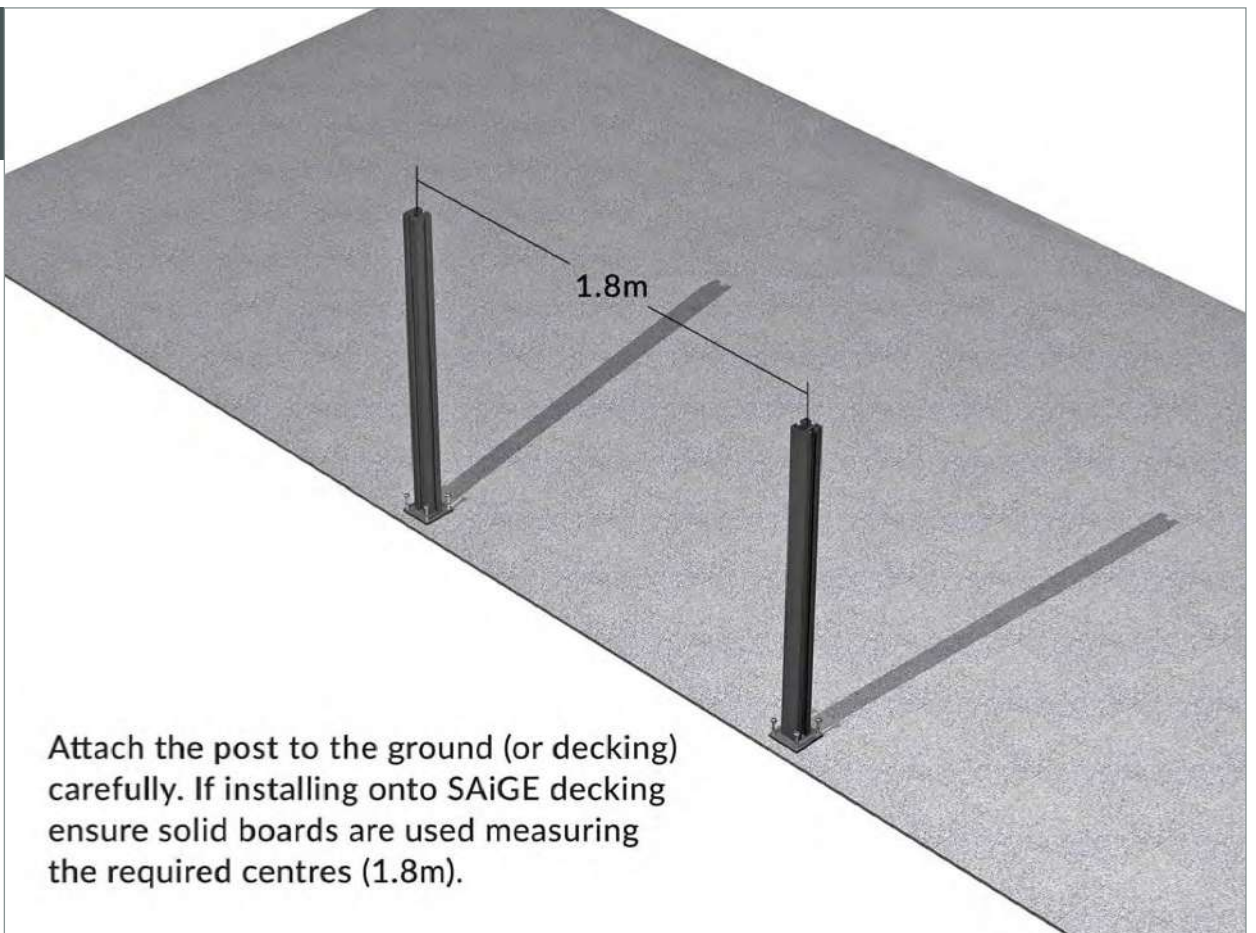

Attach the post to the ground (or decking) carefully. If installing onto SAiGE decking ensure solid boards are used measuring the required centres (1.8m).

3



Insert pieces

To create the bottom space (A) cut the provided metal inserts to the required length.



4



When inserting panels ensure the identifying rib is facing the front as in Fig 2.

Top bar

Bottom bar

Slide the bottom bar down the channel in the fence post. Do the same with the fence panel [ensure board is correct way round - see Fig 2.] to complete this section.

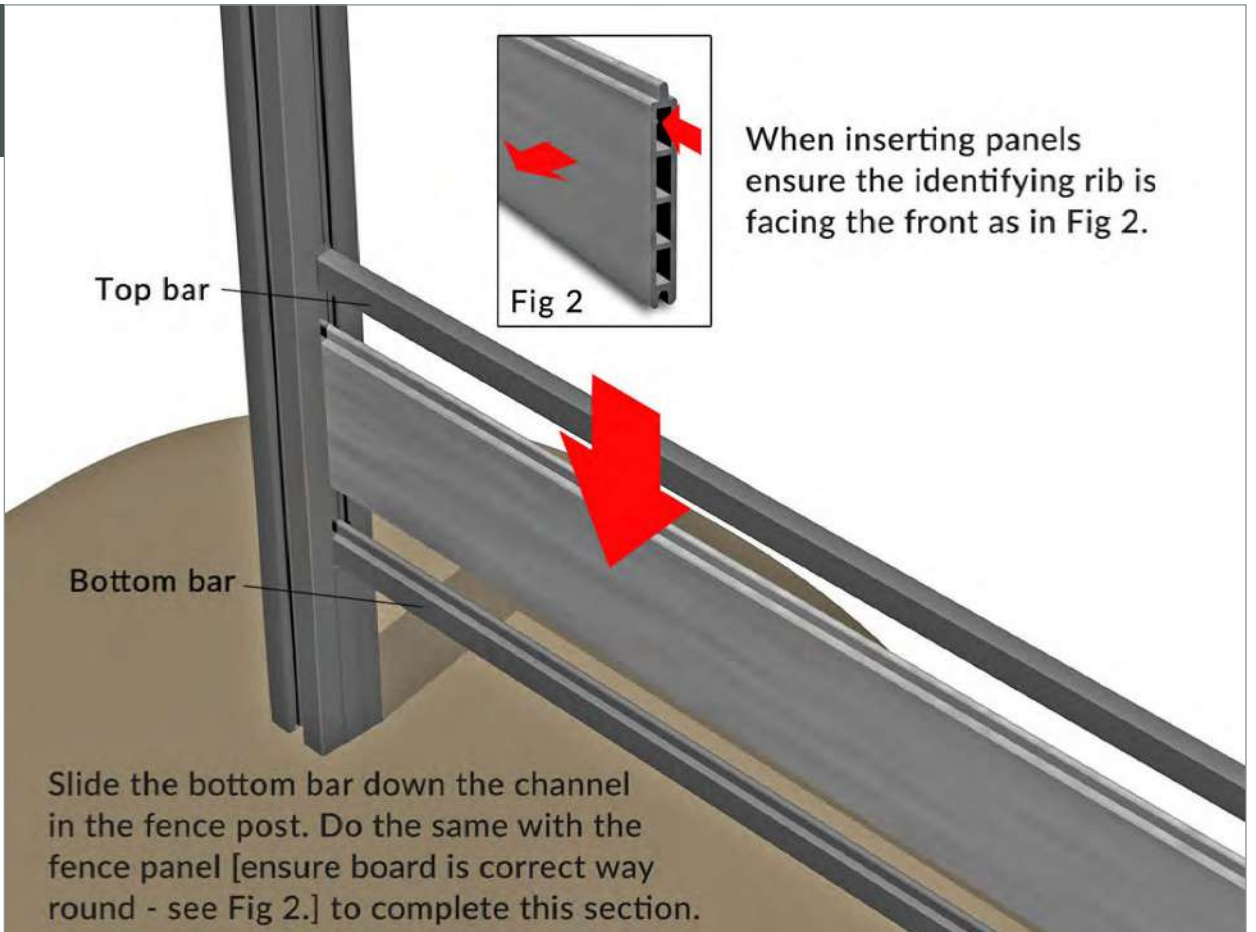

5

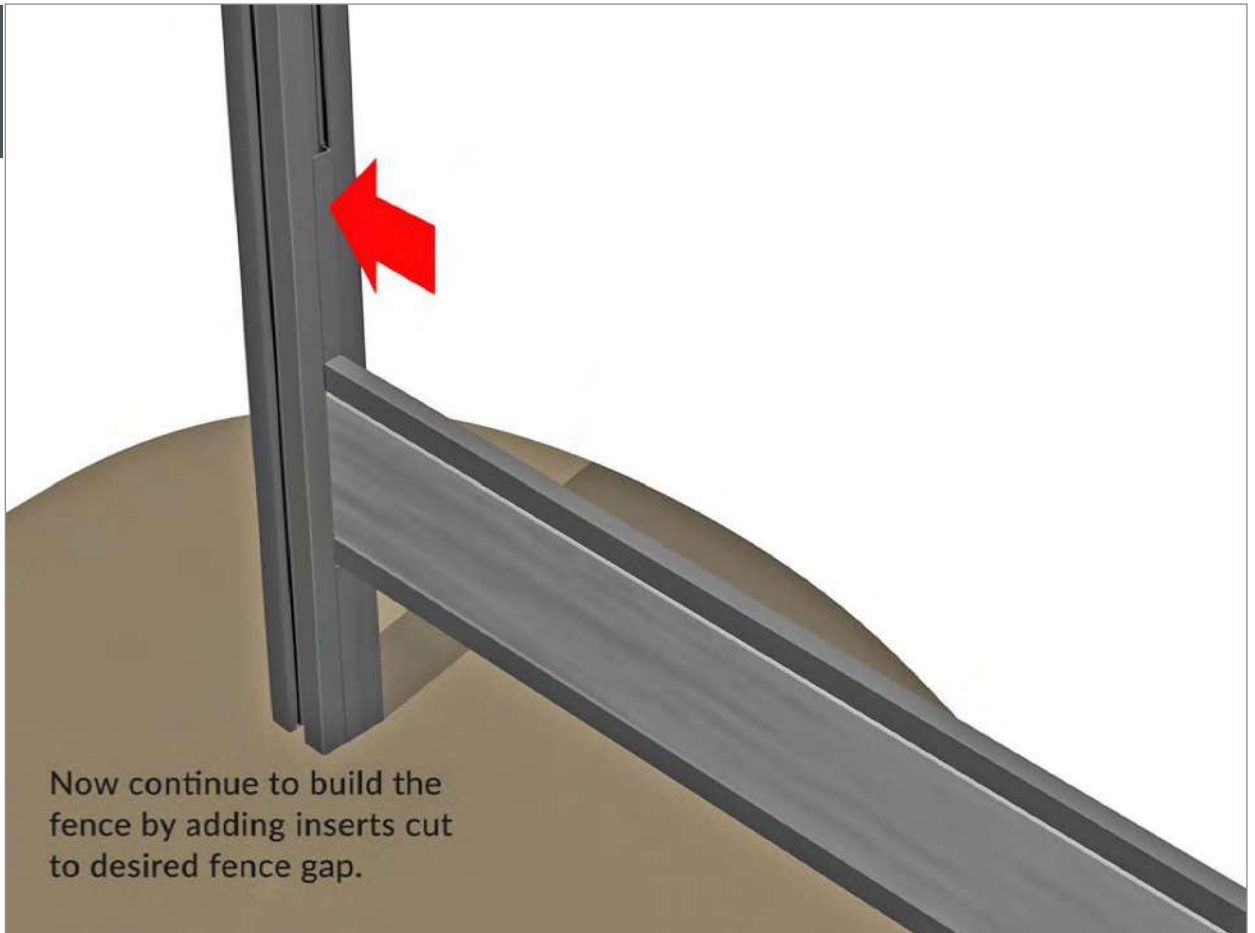

6

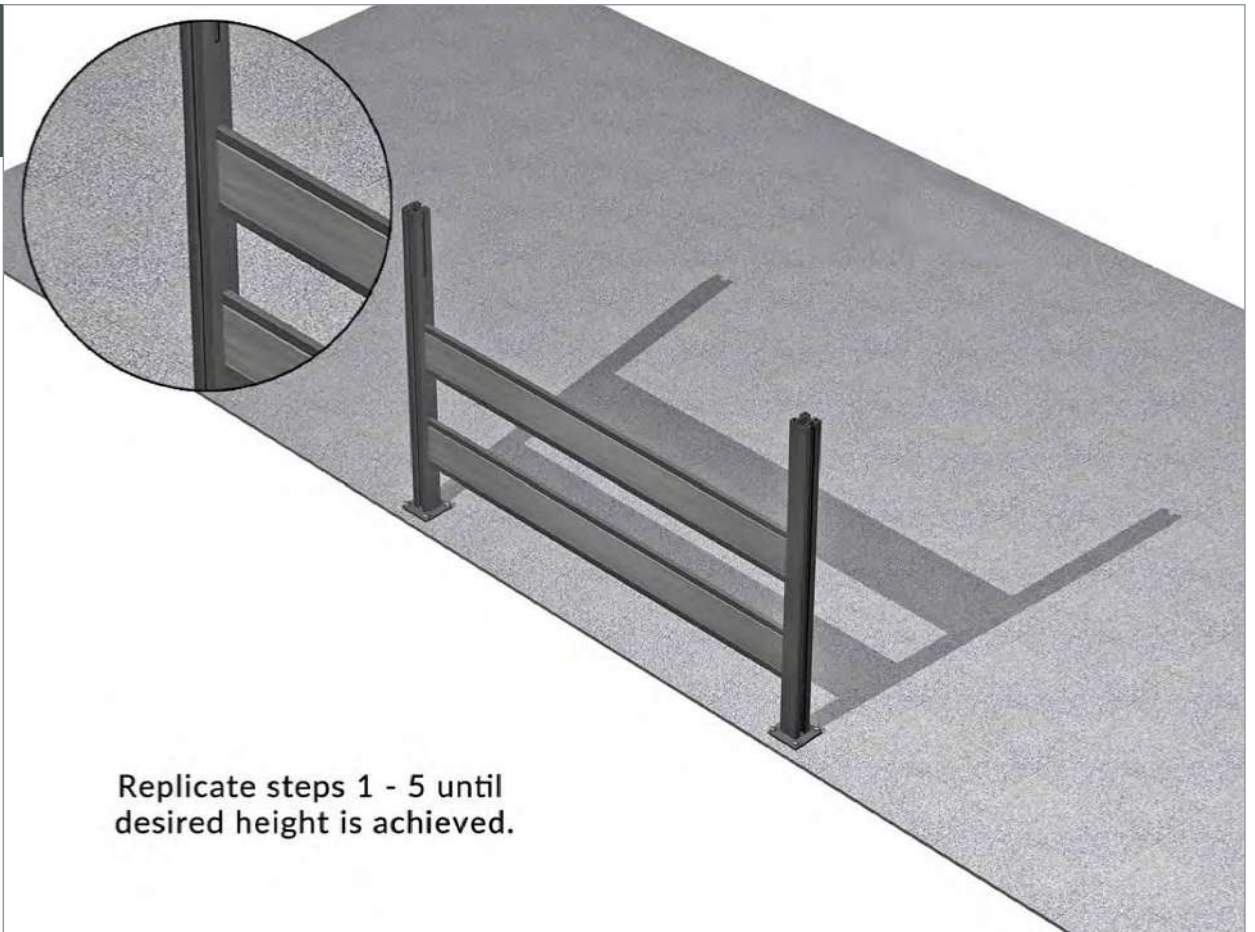

7

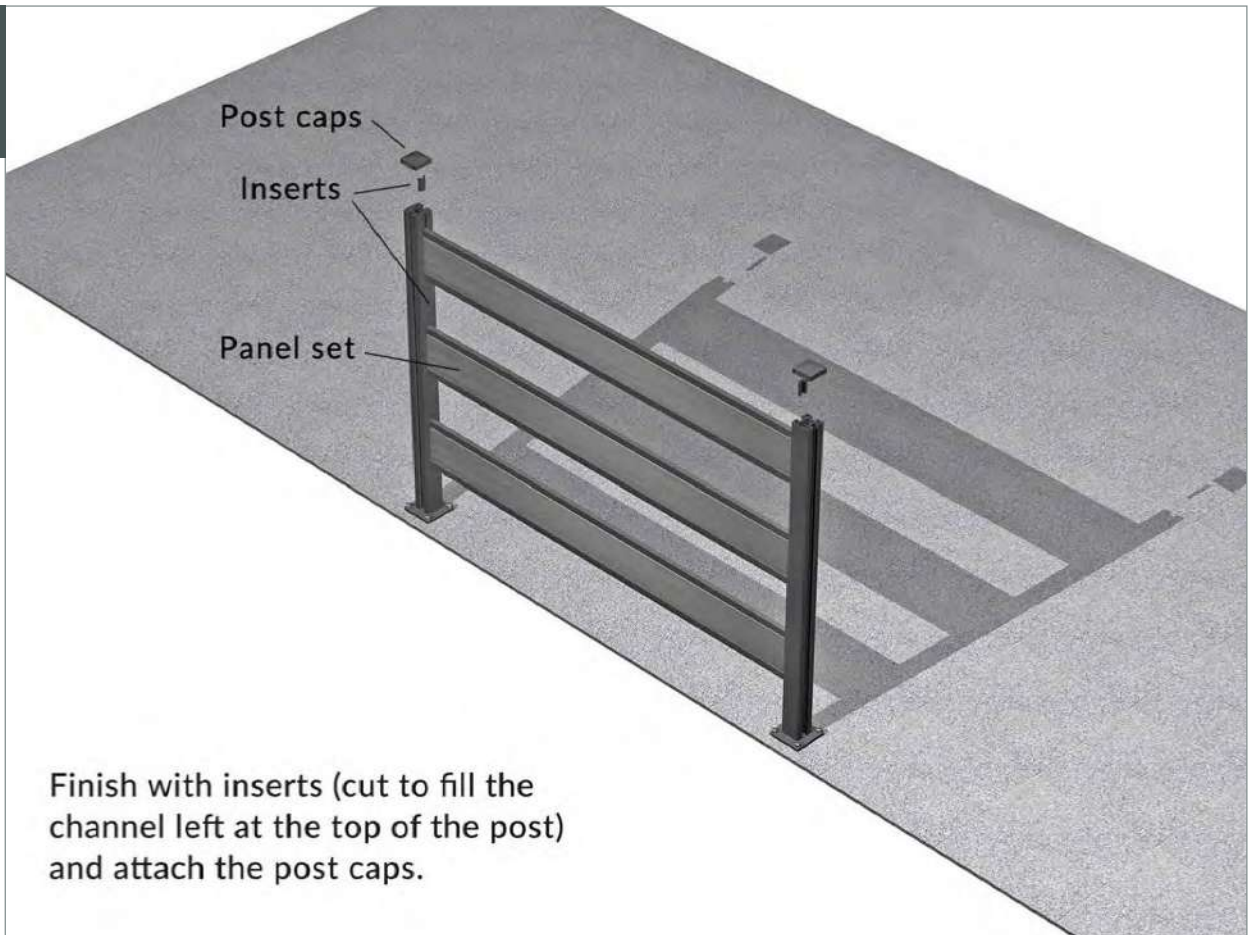

Finish with inserts (cut to fill the channel left at the top of the post) and attach the post caps.

8

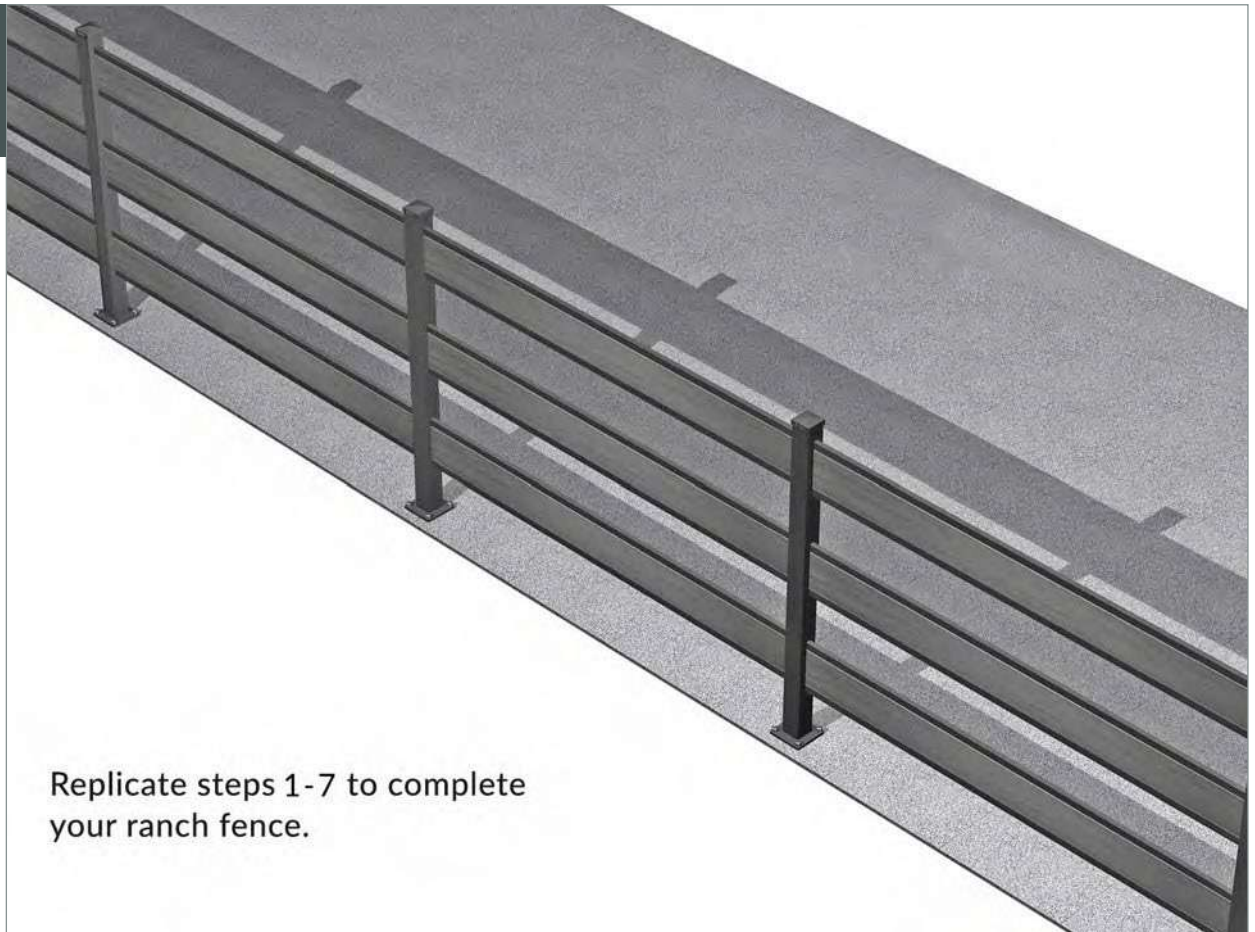

Replicate steps 1-7 to complete your ranch fence.

Composite Fences by SAiGE

Retro fit posts

1

Attach retro fit post insert to concrete post channel. The insert must be fixed to the post.



2

Position bottom bar into the retrofit post insert and slide down to bottom of the post.

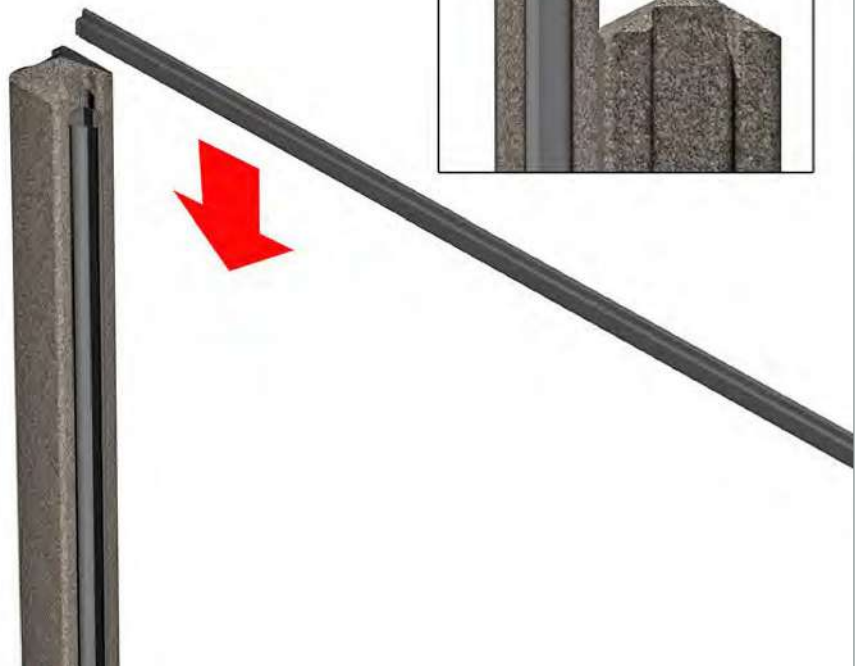

3

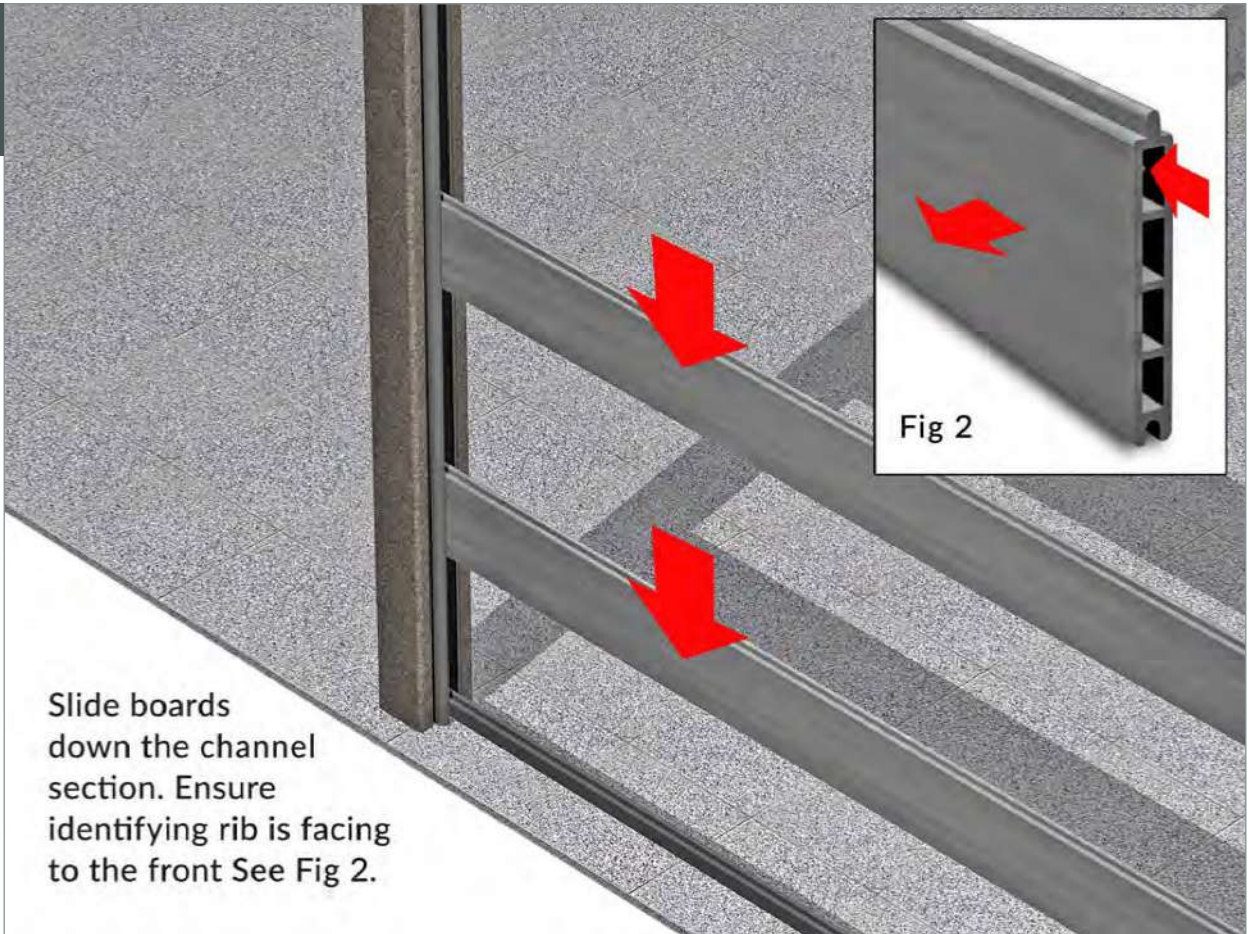

4

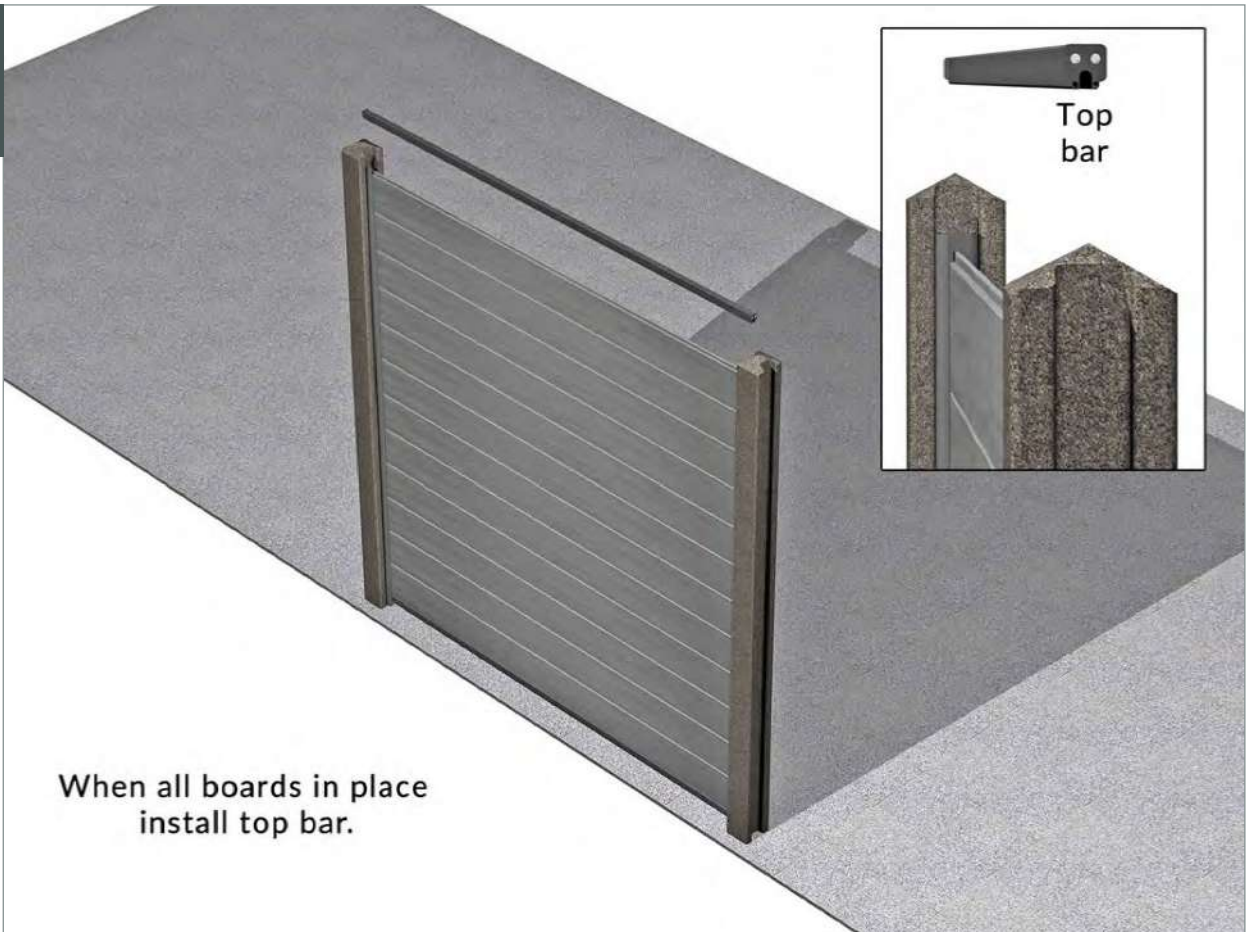

5

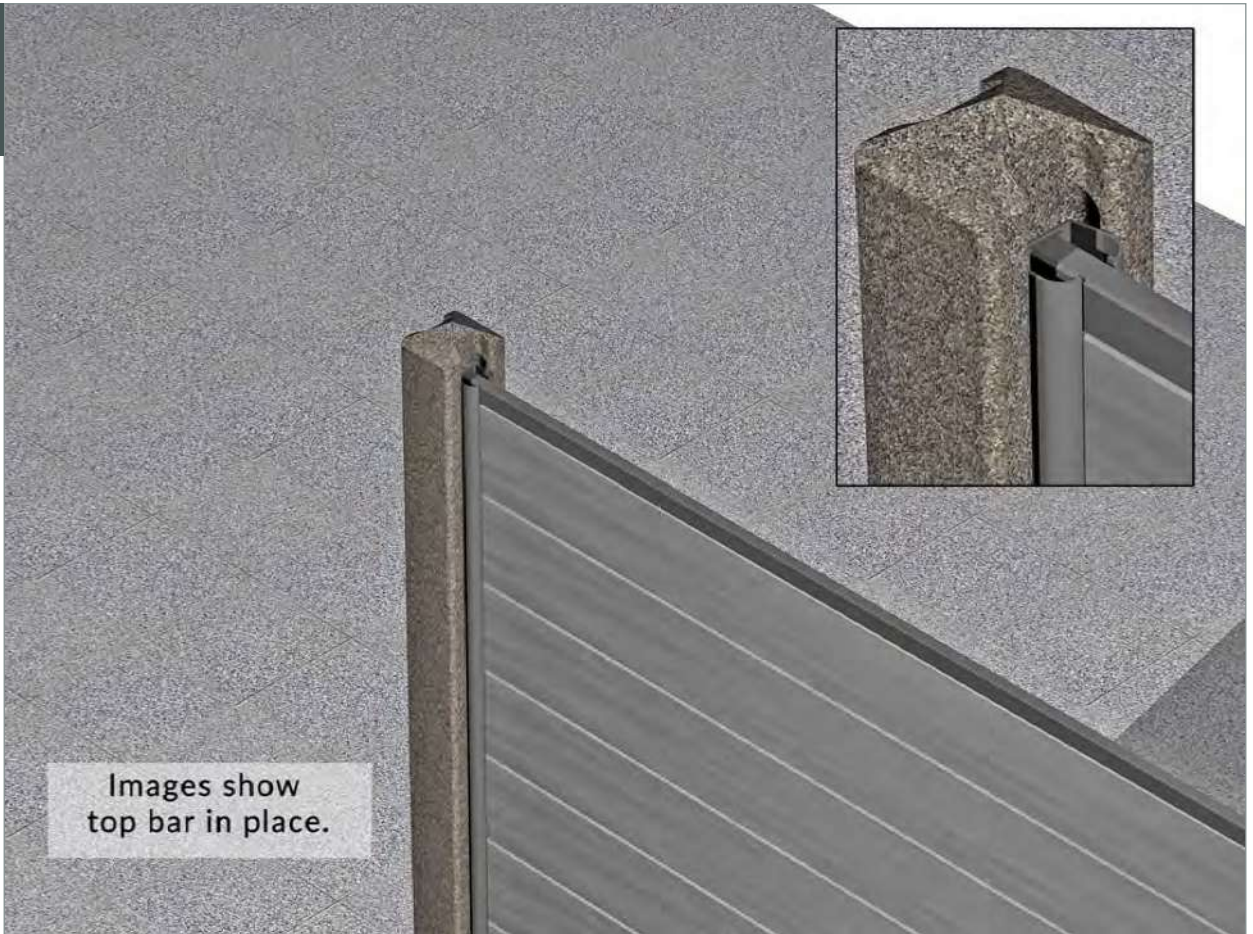

6

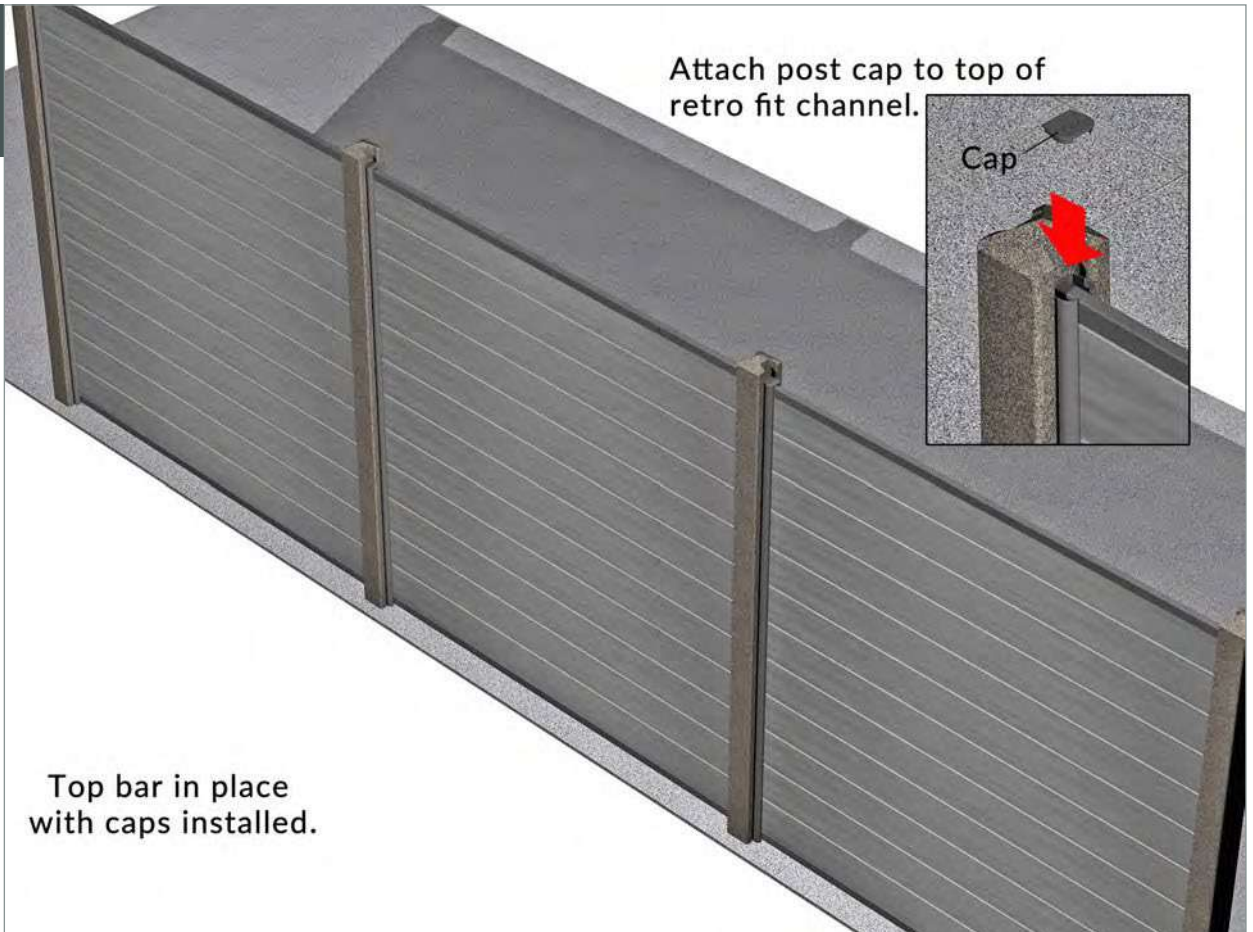

Look out for our FSC® 100% - certified products



The mark of
responsible forestry